

## DM650TM USER GUIDE

### BATTERY POWERED DIGITAL THERMOMETER WITH RELAY TRIP AND LOGGING FUNCTION

**Important - Please read this document before installing.**

Every effort has been taken to ensure the accuracy of this document, however we do not accept responsibility for damage, injury, loss or expense resulting from errors and omissions, and we reserve the right of amendment without notice.

**IMPORTANT – CE, UKCA & SAFETY REQUIREMENTS**

The instrument is designed to be directly attached to the sensor probe assembly. Remote Probes may be used but the user must ensure all sensor and cable entries maintain environmental protection to at least IP65 rating. To maintain CE EMC requirements, input wires must be less than 3 metres. The product contains no serviceable parts, or internal adjustments. No attempt must be made to repair this product. Faulty units must be returned to supplier for repair. This product must be installed by a qualified person. All electrical wiring must be carried out in accordance with the appropriate regulations for the place of installation. Before attempting any electrical connection work, please ensure the battery is removed

ABSOLUTE MAXIMUM CONDITIONS (To exceed may cause damage to the unit).	
Battery Voltage	± 3.7 VDC (Protected for over-voltage and reverse connection)
Input Voltage	± 1 V between any terminals
Ambient	Temperature (-30 to 70) °C, Humidity (10 to 95) % RH (Non-condensing)
Relays	50 VDC 40 VAC RMS



### 1~DESCRIPTION.

The DM650TM battery powered indicator accepts RTD or thermocouple temperature sensors and displays the sensor temperature in °C or °F on a 6-digit LCD display. The instrument offers an advanced display mode allowing the user to also display one or two (1 to 32) character messages. Additional to the messages, the user may select an alert event to occur when the temperature is within a band. The change-over relay can be used together with the messaging and alert to provide switching at user-set switch points. In addition to this, on board datalogging is also available to record process details at up to 5000 points.

### 2~RECEIVING AND UNPACKING.

Please inspect the packaging and instrument thoroughly for any signs of transit damage. If the instrument has been damaged, please notify your supplier immediately.

### 3~SPECIFICATION.

Refer to data sheet for full specification.

Factory default	Pt100, °C, 0.0°C offset, relay not set
-----------------	--

### 4~ INSTALLATION AND WIRING.

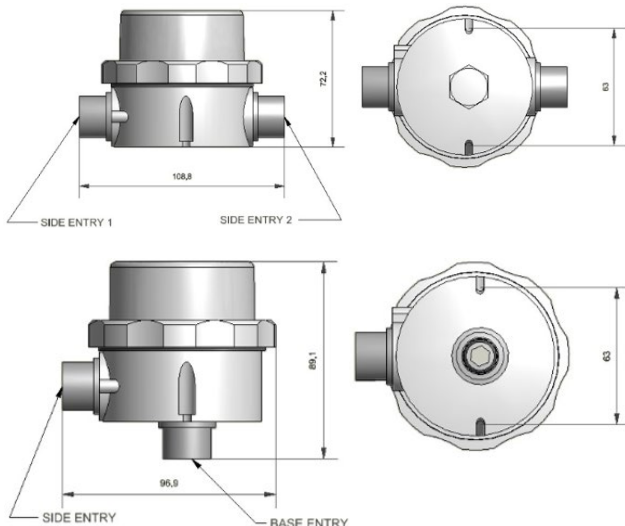

### 4.1~MECHANICAL.

The instrument is a high accuracy digital thermometer. In order to ensure correct operation, the following must be observed:  
The product must be stored in a dry clean environment and remain in original packaging prior to installation.  
The instrument must not be installed adjacent to electro-mechanical starters, controllers, thyristor power units or electrical switch gear.  
Any cleaning of the instrument must be done using a mild detergent and soft cloth. No solvents or abrasive cleaners should be used.  
Stated ambient operating conditions must not be exceeded. Battery life will reduce with higher ambient temperature operating conditions.

### 4.2~ELECTRICAL.

**For a wiring diagram please refer to the rear panel of the DM650TM inside the case housing.**

Two-part connectors are used for input and relay connections, allowing the unit to be easily removed from the housing for reprogramming or data download if this is not possible in situ. On insertion of battery the unit will run through a power up check; during this time the relay may change state.

**IMPORTANT:** Always remove battery before any wiring takes place. Gain access to the connectors and battery holder by twisting cap to release front panel assembly from case.

**RTD:** For best result we recommend using three wire connection; this method compensates for any lead resistance between the sensing element and instrument. Two wire connection is possible: refer to connection diagram on the instrument protection panel.

**THERMOCOUPLE:** T/C wire type must be maintained from the sensor element to the instrument terminals. The terminals are effectively the cold junction point and can be displayed as "Case" temperature.

**RELAY CONNECTION:** A relay with changeover contacts is available. Screw terminals are provided for connection for wire size 16 to 20 AWG. The relay contacts are rated at 48 VDC 28 VAC RMS @ 1 A (5 mA minimum current) see DM650TM data sheet.

**BATTERY:** To remove battery, use screw driver to ease the positive end of the battery out of holder. Insert new battery negative end first then press into place. (Observe polarity). Battery type 3.6 V Lithium (2.4 A/Hr) CR14505 (IEC) AA case style. Please dispose of the battery in a responsible way.

### WARNING

For configuring, reading live data or reading logged data if using a grounded thermocouple probe on the input, it is important not to connect the programming USB lead to a mains powered computer. It is possible to damage the instrument if connected in this way.

To avoid damage use one of the following methods:

- Disconnect the probe before configuration, reconnect the probe after configuration.
- Ensure the probe and DM650 housing are not in contact with any conductive parts during configuration.
- Use a laptop type computer running from its battery power supply, not connected to a mains supply. This is recommended for reading lived data or offsetting a unit if already installed in the field.
- Use a USB isolator between the computer and the DM650.

### 5~USER CONFIGURATION.



**READ COMPLETE SECTION BEFORE ATTEMPTING CONFIGURATION. PARTICULAR CARE SHOULD BE TAKEN REGARDING TIMEOUTS IN MENU 2 & 3**

The instrument is provided with a USB interface for direct connection to a PC. Free software USBSpeedLink is available. Please refer to the USBSpeedLink software for further information on configuration. The software can be downloaded from [www.status.co.uk](http://www.status.co.uk).

**DISPLAY:** The display provides six 14 segment characters for display of temperature and alpha-numeric messages, together with a 8 segment bar graph and six icons. The display is capable of operating in an ambient temperature range of (-30 to 70) °C, but at temperatures lower than -5 °C (due to the slower LCD speed) scrolled messaging is not practical, so the display will automatically revert to basic mode showing temperature. The display's high contrast, coupled with a digit height of 7.9 mm, offers clear readouts at low as well as high ambient light and direct sunlight.

The display layout is as follows:

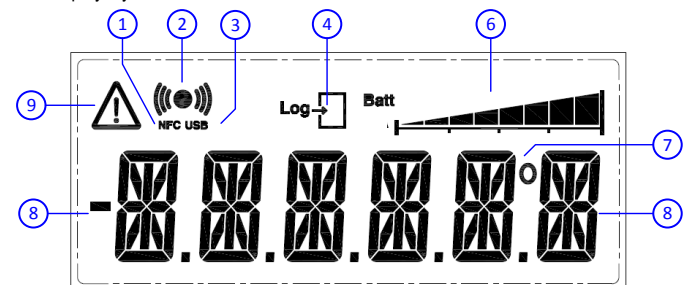

## 5~USER CONFIGURATION (continued).

1. NFC - The Symbol is on when a NFC field is detected. When a detected field is lost the symbol will turn off after a few seconds.
2. TRANSMIT/RECEIVE: Symbol on when either NFC or USB communication is active.
3. USB: Symbol on when USB port is connected to a PC. Please note battery is not required during configuration.
4. LOG: Not used
5. Not used
6. BAR GRAPH: Indicates the state of the logger. The condition is dependent on the selected logger mode, either Single or Rolling mode.

Single Mode (Log to the maximum number of logs then stop)

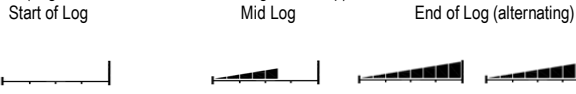

Rolling Mode (Log to the maximum number of logs then as each new log is taken the oldest log is discarded)



7. DEG: Degree symbol "°" used to indicate either °C or °F on the last digit.
8. DIGITS: Six-digit 14 segment display with – sign, range 9999.9 to -9999.9. Advanced mode offers two temperature-dependent 32-character message options.
9. WARNING ICON: This symbol will toggle on and off to indicate a warning. The warning symbol will be active either when the sensor signal is out of range, not connected or when the battery is low.



### MULTIFUNCTION ALERT LED

The alert LED normal state is off, on alert the LED will emit a intense white light pulse every 5 seconds. The LED can be programmed to pulse on any of the following combined events:

Mode	Description
No events	The LED never operates, extending battery life. (Factory default setting)
Battery	Alert on low battery detect.
Trip	Alert when relay 1 trip is on.
Temperature	In advanced mode only the alert LED can be made to alert in any one of eight user-set temperature bands. Example, to alert operator when temperature is outside a safe operating range. The function of the alert LED can be further enhanced with the option of displaying an alert message in advanced display mode.



### NFC LOGGER INTERFACE

The NFC interface allows the instrument to communicate with an Android device using NFC connectivity. The prime function of the interface is to read logged data from the device using a free app, which is available for downloading to Android devices.

The app allows the user to read existing logs, change the log manifest, start a new log, synchronise the instrument clock and reset the maximum/minimum/average readings. Logs can run to a fixed number and stop or continually roll over, up to 5000 log points can be recorded. The start of the log can be delayed up to one month. Note: For larger logs the data may take over a minute to fully download via the NFC interface.

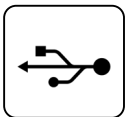

### USB LOGGER INTERFACE (connector inside housing)

The USB interface allows the instrument to communicate with a PC running the USBLogLink software

The prime function of the interface is to read logged data from the device using free software available to download. The software allows the user to read existing logs, change the log manifest, start a new log, synchronise the instrument clock and reset the maximum/minimum readings. USBLogLink is available from the manufacturer or supplier.

## USBLogLink CONFIGURATION SOFTWARE

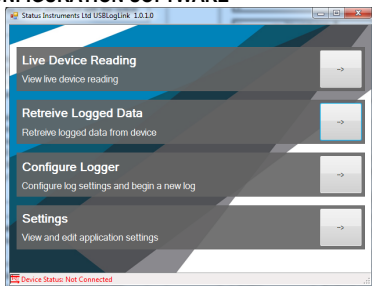

LIVE DEVICE READING TAB	
Display	Live temperature value
RETRIEVE LOGGED DATA TAB	
Download and graph recorded logged data	
CONFIGURE LOGGER	
Set new log (rolling or fixed), interval time, number of logs, delay start	
Enter (tag and contact), reset (max and min) Sync clock	
SETTINGS	
Save log location, °C, °F	

## 5~USER CONFIGURATION (continued).

### USBSpeedLink CONFIGURATION SOFTWARE

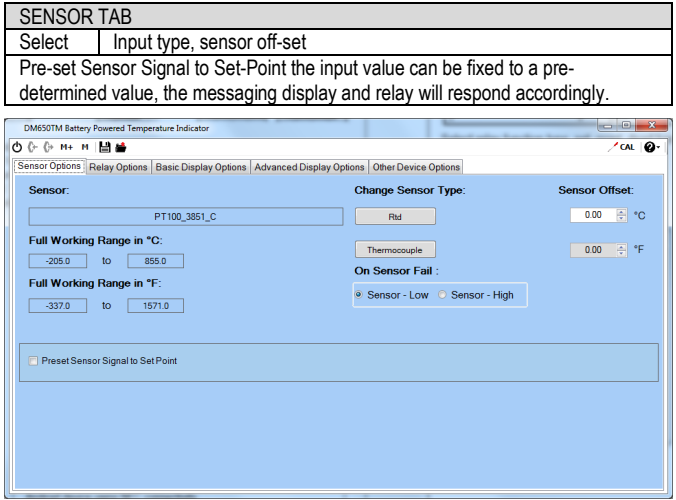

DM650TM configuration software (Sensor Options Tab).

RELAY OPTIONS TAB	
Select	Select relay operation, set -point, dead band, relay name

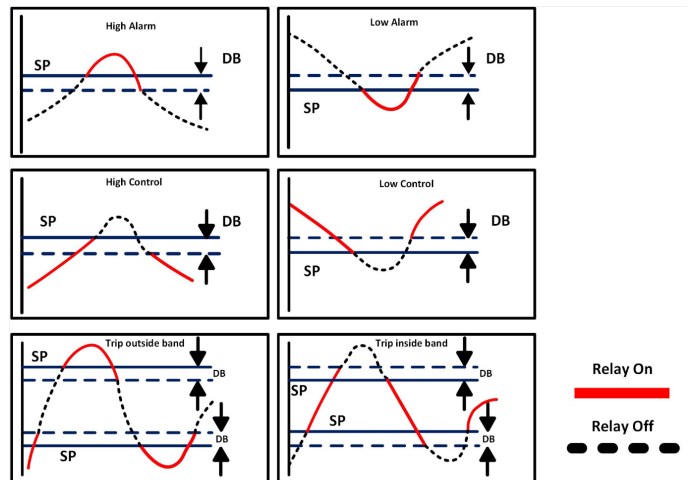

BASIC DISPLAY OPTIONS TAB	
Select	Display units, resolution, Zero set-point
Select	LED Options for battery, relay

ADVANCED DISPLAY OPTIONS TAB	
Select	Message bands, custom messages
Use this software tab to set up advanced scrolling user messaging	

OTHER DEVICE OPTIONS TAB	
Enter	Tag, contact details
Enter	Android passkey (protect logged data)
Enter	Device location
Read/clear	Maximum and minimum reading
Synchronise	Clock



This document is subject to change without notice. No responsibility is taken for errors.  
**Status Instruments Ltd, Status Business Park, Gannaway Lane, Tewkesbury, Gloucestershire, UK, GL20 8FD**  
**Web Page: [www.status.co.uk](http://www.status.co.uk), Email: [sales@status.co.uk](mailto:sales@status.co.uk)**  
**Technical Support: [support@status.co.uk](mailto:support@status.co.uk)**  
**Tel: +44 (0) 1684 296818, Fax: +44 (0) 1684 293746**